

# A Hybrid Approach for Optimized Resource Allocation in a Deployed 4G Long Term Evolution (LTE) Network

Bisma<sup>1</sup>, Ravinder Pal Singh<sup>2</sup>, Jasmeen Gill<sup>3</sup>, and Dr. Monika Mehra<sup>4</sup>

<sup>1</sup>Research Scholar, Department of Research, Innovations and Incubation, RIMT University, Punjab, India

<sup>2</sup>Technical Head-Department of Research, Innovations and Incubation, RIMT University, Punjab, India

<sup>3</sup>Research Associate, Department of Research, Innovations and Incubation, RIMT University, Punjab, India

<sup>4</sup>Head, Department of Electronics and Communication Engineering, RIMT University, Punjab, India

Correspondence should be addressed to Bisma; bismaj68@gmail.com

Copyright © 2023 Made Bisma et al. This is an open access article distributed under the Creative Commons Attribution License, which permits unrestricted use, distribution, and reproduction in any medium, provided the original work is properly cited.

**ABSTRACT-** A 4G system is expected to provide an all-inclusive and secure all-IP based mobile broadband solution to laptop, wireless modems, computer, smart phones, and other mobile devices. Although many studies were conducted in the past, there are still many challenges to be met when resource allocation is to be performed in an optimal manner. In the light of the same, a hybrid approach for optimized resource allocation is proposed in a deployed 4G Long Term Evolution (LTE) network. For this to accomplish, firstly a comparative study of the state-of-the-art models has been performed to find out the most optimal method for resource allocation and then propose a hybrid approach to blend the merits of two or more techniques. So, in this article, four main techniques, namely, Binary Phase Shift Keying modulation (BPSK), Quadrature Phase Shift Keying (QPSK), Quadrature amplitude modulation (QAM), Orthogonal Frequency Division Multiplexing (OFDM), as modulation techniques have been compared. Since, OFDM outperformed the other modulation techniques, so, it has been integrated with QPSK and OFDM to obtain the most optimal resource allocation. Experimental results show that the proposed technique is simple and robust, and quite promising in the near future for deployed 4G LTE networks.

**KEYWORDS-** 4G systems, Long Term Evolution (LTE), Binary Phase Shift Keying modulation (BPSK), Quadrature Phase Shift Keying (QPSK) and Quadrature amplitude modulation (QAM), Orthogonal Frequency Division Multiplexing (OFDM)

## I. INTRODUCTION

In the recent years, the need of people to be “Best connected forever” has increased to a great extent. For connecting the people easily and to accomplish the needs of people there has been a vast development in mobile wireless access technology.

A 4G system is expected to provide an all-inclusive and secure all-IP based mobile broadband solution to laptop, wireless modems, computer, smart phones, and other mobile devices. A 4G system Services such as extreme-broadband Internet access, IP telephony, gaming services, and streamed multimedia may be provided to users. The 4G technologies are designed to provide IP- based voice, data and multimedia streaming at speeds of at least 100 Mbit per second and up to fastest as 1 Gbit per second. 4G LTE is one of numerous opposite 4G standards end to end with Ultra Mobile

Broadband (UMB) and WiMAX (IEEE 802.16), reduced inactivity, accessible bandwidth capacity, and in reverse compatibility with existing GSM and UMTS technology. Future developments to produce highest throughput of the order of 300 Mbps (Shih-Lian Huang, 2005; S. Wildstrom, 2009). However, the most imperative task in a network is allocation of resources that too in an optimal manner. Although a number of studies have been conducted in the past, optimality in resource allocation is always a challenging task to achieve. If effective modulation technique be applied in 4G systems, resources can be allocated optimally.

There are several modulation techniques being proposed in the literature. These are Binary Phase Shift Keying modulation (BPSK), Quadrature Phase Shift Keying (QPSK), Quadrature amplitude modulation (QAM), Orthogonal Frequency Division Multiplexing (OFDM), to name a few. Finding out the best modulation technique is an issue to be resolved so that efficient systems be proposed. Therefore, there is a need for an extensive comparative analysis of the modulation techniques thereby proposing the best suited most optimal techniques to be deployed in 4G networks.

The remaining article is organized as follows: a brief literature survey is provided in Section 2, details of proposed model and methodology are given in Section 3, results and discussions are presented in Section 4, and the conclusions are summarized in Section 5.

## II. LITERATURE REVIEW

Several endeavors (Xiang et al., 2007; Elayoubi et al. 2008) in the field of resource allocation in deployed 4G LTE Networks have been put. The origins of Ad Hoc networking lie in a 1972 US Department of Defense project known as Packet Radio Network (PRNET), in conjunction with ALOHA and CSMA (Carrier Sense Multiple Access), approaches for medium access control and a kind of distance-vector routing, PRNET were used on a trial basis to provide different networking capabilities in a combat environment. According to Assad (2008), first generation of network came into use for the first time in July 1978 in USA. 1G consisted of distributed transceivers that helped in communicating with mobile phone. The mobile phone structure was analogue and it could only be used for voice traffic where frequency division multiple access (FDMA) techniques where the user had to wait for the first user to hang up were used.

Another attempt was made by Kubbar et al. (2012), cell phone is continuously evolving at a fast-tracking rate of invention. It is adopted from first generation to and achieved the current fourth generation (4G) network. The previous generations of mobile gives guarantee for QoS for voice infrastructures.

Yet another model was proposed by Ahmad et al. (2015) describing Long Term Evolution as a radio access network developed by 3rd Generation Partnership Project (3GPP). The LTE is an extension from WCDMA-UMTS of the Third Generation Network (3G). The 3GPP identical the Long Term Evolution with the aim to develop a system capable of accommodating low-latency high speed data requirement.

It is reported that the traffic QoS parameters (throughput, delay and loss rate) are not enough in a wireless environment. Whereas in a wireless environment, connections may temporarily break during a process termed handoff (Jahangir et al., 2015). Likewise, Zhao et al. (2016) found the fact that in physical layer, growing the power of the source signal and using spreading techniques can increase its flexibility against interfering. While the prospect of interference is significant, it is easy to detect and tackle and its impact on the WIMAX/LTE network and users will be limited. The important reason for the transition to the All-IP is to have a common Platform for all the technologies that have been developed so far, and to harmonize with user expectations of the many services to be provided. The major difference between the GSM/3G and All-IP is that the functionality of the RNC and BSC is now distributed to the BTS and a set of servers and gateways. That means this network will be less expensive and data transfer will be much faster according to these (Zhang et al., 2008).

According to Van et al. (2013), new technologies came into existence and also demand increasing day by day for high speed and quality of service at low cost. Previously macro cell, micro cell, and pico cell were used but now Femto cell which exist in in the home or with in the office are expected to perform a lot of tasks so need to adapt advanced algorithm to optimize the resources be done.

Similarly, Wang and Hsieh (2016) described the fact that the LTE-A present deployment strategies are expected to overcome the User Equipment (UE) performance poverty, in definite parts of the topology incorporated with coverage block holes, due to the presence of high rise buildings. It also possibilities to serve the increase of high user density, which otherwise results in capacity exhaustion of the macro cells. The LTE-A speeches these challenges with new features such as small cell and femto cell in its recent releases. The Small cell is a low-cost alternative to macro cell in rural and hard-to-reach areas and its installation at strategic points overcomes the capacity and coverage problem. In difference, Heterogeneous network with its universal coverage can deliver high-speed data.

Yet another study performed by Tang et al. (2013), the OFDM is a multicarrier digital communication design. It comprises of a large numbers of low data rate carriers to create a very high rate communication system. Orthogonally allows carriers to be personally spaced, even overlapped with no interference. Each carrier will removes low data rate inter-symbol interference. The OFDM (Orthogonal Frequency Division Multiplexing) is most well-regarded method for very high data rate transmission in wireless communication, robustness to multipath fading, a very high spectral capability and also a very high liveness in resource allocation. The

MIMO-OFDM scheme is very good for the coming 4G wireless communication systems. The MIMO improve the capability and diversity and OFDM appropriate for high data rate transmission over multipath fading channels. In MIMO systems, the data flow from a single user is DE multiplexed into an amount of transmits antennas separate sub streams.

Despite the extensive literature and research available on 4G LTE Network systems, the field has not progressed beyond basic technology. In real time scenarios, there are numerous challenges to be met for instance resource allocation and its optimization. Perhaps, this could be a possible reason for availability of very few contributions related to model that can optimally resolve resource allocation issues. Therefore, an efficient and optimized resource allocation process for 4G LTE networks is the need of the hour and thus, got the motivation of the present system to reach a high level of optimality for resource allocation.

### III. MATERIALS AND METHODS

The most imperative task in 4G LTE Network systems is the input being fed to the system. The input is fed as digital data to the 4G LTE Network systems and the output is received as a graphical form of throughput of the system. The major components of 4G LTE Network system are shown in Figure 1.

The detailed modulation technique-based resource allocation model used for achieving optimality in deployed 4G LTE networks has seven major phases: Input unit, digital modulation, ODFM/PSK, Noise Addition, FFT, Demodulation, output unit, as shown in figure 2.

Since the motivation of this work if bi-fold, firstly to study and analyze the different techniques of resource allocation with respect to 4G LTE network. Secondly, to improve the resource allocation using hybrid optimized approach in a deployed 4G LTE network.

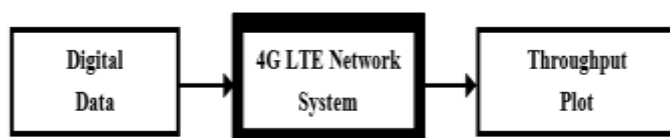

Figure 1: Components of 4G LTE Network System

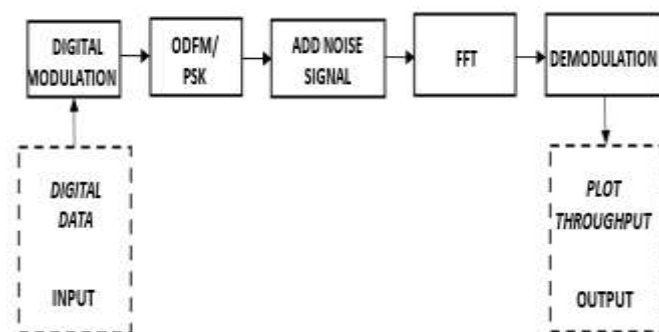

Figure 2: Block Diagram of Optimized Resource Allocation in a Deployed 4G LTE Network

In order to achieve this the digital data are first modulated using some modulation techniques, for instance, Binary Phase Shift Keying modulation (BPSK), Quadrature Phase Shift Keying (QPSK), Quadrature amplitude modulation (QAM), Orthogonal Frequency Division Multiplexing

(OFDM). Afterwards, some kind of noise is being added to it and thereafter FFT is being applied over it. Then, the demodulation process is carried out and finally the output is received in the form of throughput graphs that are analyzed further, to effectively optimize the process of resource allocation in 4G LTE Networks. The steps of the algorithm followed are demonstrated in figure 3.

First step is to set the parameters and assign some initial values to these. Afterwards, generate random digital data by the MATLAB in-built function `randsrc()`, thereafter, perform digital modulation by another in-built function as `pskmod()`. Also, insert redundant bits (pilot) with data using `hadamard()` matrix so as to give it uniformity wherever data is missing.

After insertion of redundant bits also known as padding, convert serial data into parallel form. Thereafter, generate OFDM signal by performing two main functions: `IFFT (data)` and `reshape ()`. This is the main step where modulation of data is being performed. Then, add cyclic prefix. The data shall be again reciprocated and hence, be converted from parallel into serial form.

Thereafter, send the signal from multiple antennas while varying the speed of the node and hence, repeating step 3 for different modulation techniques. Apply the main modulation techniques one by one to check the performance of each in terms of optimality of resource allocation in 4G LTE network system. The techniques are: Binary Phase Shift Keying

modulation (BPSK), Quadrature Phase Shift Keying (QPSK), Quadrature amplitude modulation (QAM), Orthogonal Frequency Division Multiplexing (OFDM).

Afterwards, add noise with signal using another MATLAB in-built function `awgn (signal, SNR)`. Then, convert received signal into parallel form, remove cyclic prefix, and again perform `FFT ()` as a reciprocating technique to `IFFT`, thereafter, the data is reconverted to the serial form. Now, remove pilots also known as channel estimation.

Then, started the task of demodulating the original digital data which was modulated and noise added and then removed to obtain optimal results. So, perform demodulation using `pskdemod ()`. Now, two main parameters have been computed, namely, bit error per packet lost and end-to-end delay. Biterror/packet lost would be computed using another MATLAB function `biterr()`. Subsequently, calculate end-to-end delay.

In order to get a clear picture of the output, plot bite errorrate and end to end delay. Finally, the throughput is plotted.

#### IV. RESULTS AND DISCUSSION

MATLAB has been used for implementation. MATLAB stands for “matrix laboratory”. It is a multi-hypothesis numerical computing environment and registered programming language developed through Math Works.

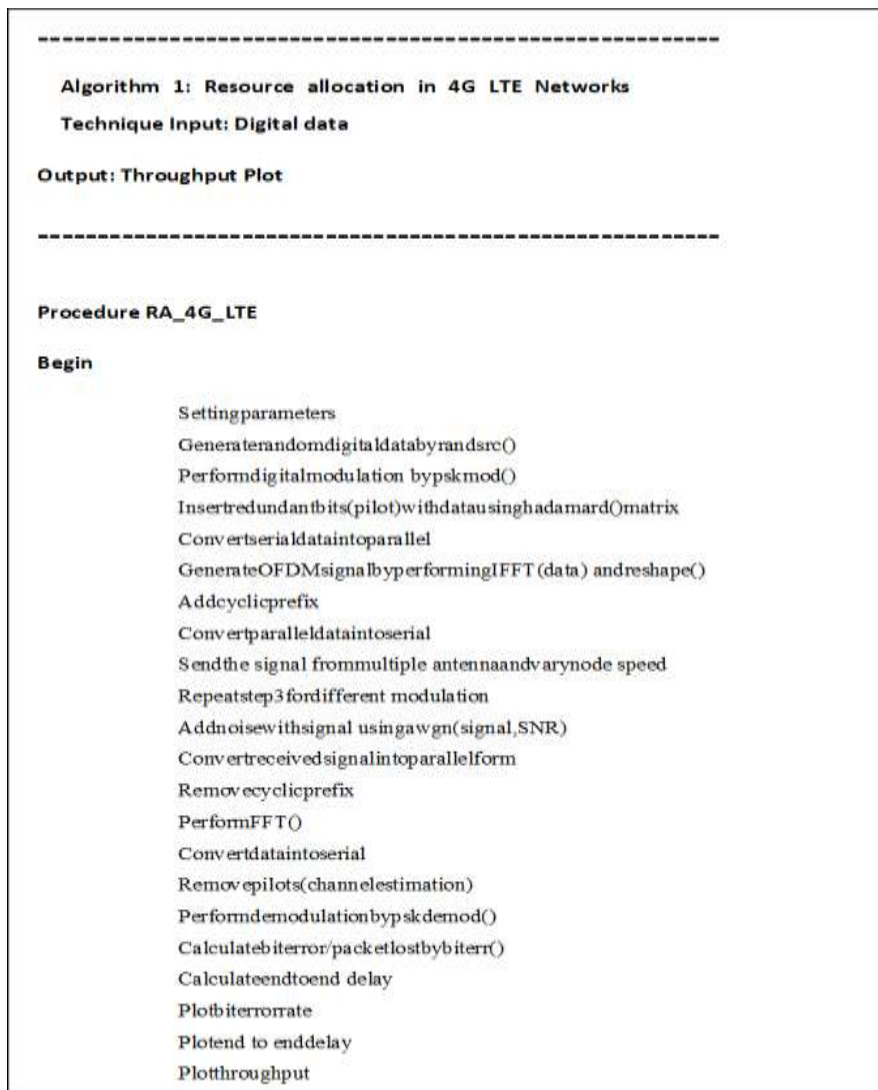

Figure 3: Steps of Region Segmentation



Even though MATLAB is proposed for numerical computing, as we know that MATLAB is not only a high-performance language but also used for technical computing. It is easy to use programming environment. It incorporates calculation, visualization, and where problems are expressed and get result as solutions are expressed in conversant mathematical notation. Many uses include: Development of Application, another one is GUI (Graphical User Interface) based application.

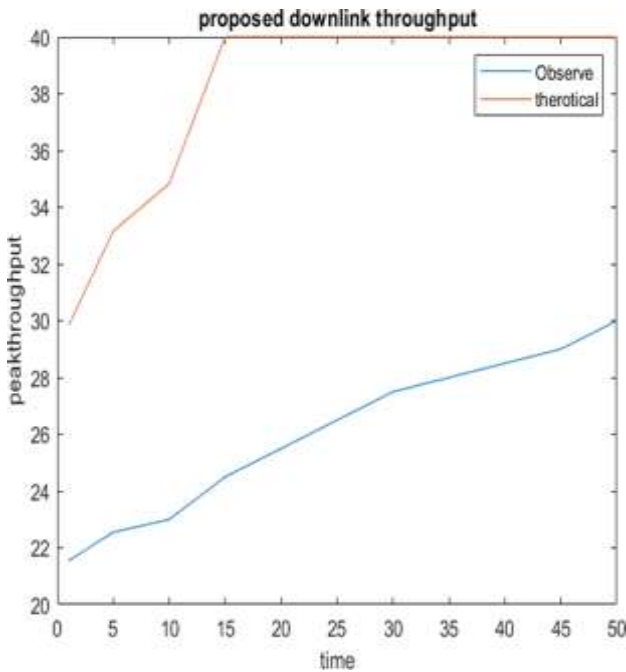

Figure 4: Downlink throughput vs Peak Throughput (Observed vs Theoretical)

In figure 4, comparative analysis of 4G LTE based on performance in new communication is visible. In figure 5 the result for Amplitude and OFDM signal are shown. Figure 6 demonstrates the results about the amplitude and transmitted data.

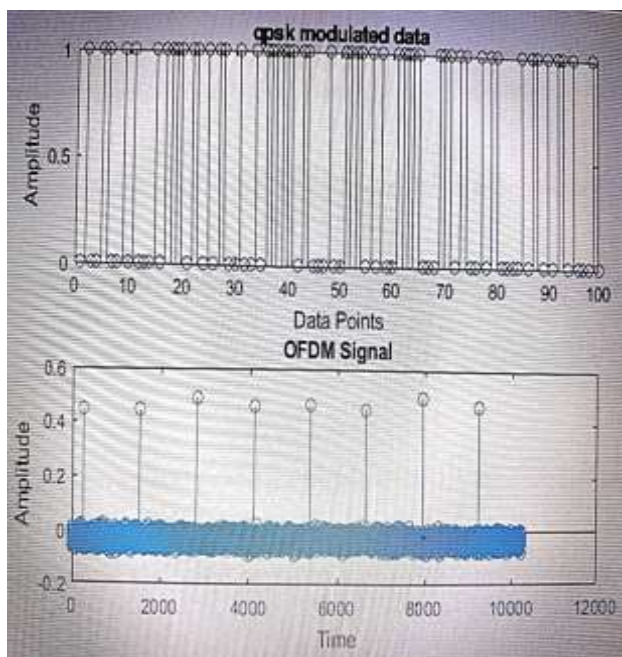

Figure 5: QPSK Data and OFDM Signal

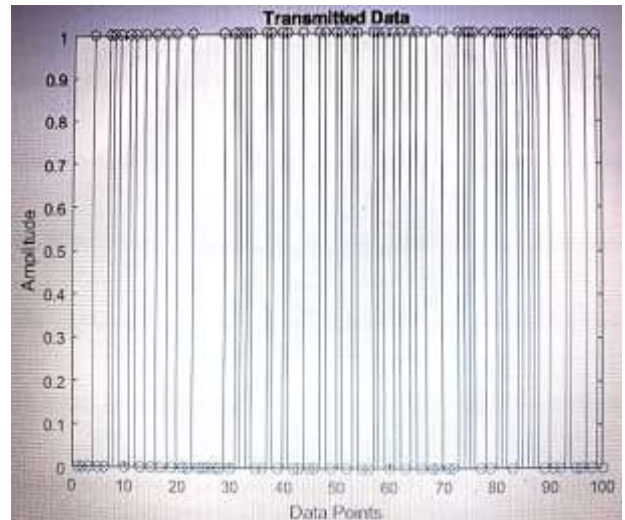

Figure 6: Transmitted Data vs Data Points

This research is basically performance comparison of various latest wireless communication technologies. We have used different modulation scheme and different hardware design (multiple antenna at TX and RX) and different wireless environment (AWGN and Rayleigh channel) for different operators. We have used BPSK, QPSK and QAM as modulation techniques we have also used OFDM (orthogonal frequency division multiplexing) for higher bandwidth and mobile units or nodes are moving. We have used MATLAB 2017 for implementation. We have various operators and these are classified on the basis of hardware (number of antennas at base station and other hardware) they are using, channel estimation methods they are using, data rate they are providing, data lost (bit error rate) due to environment etc. As we discussed earlier that this research is based on performance analysis of 4G wireless communication system; communication system is affected by several atmospheric parameters such as noise, fading, temperature variation and noise inside the electronic equipment's. Due to these parameters data speed, data quality, end to end delay time etc. are affected. We have investigated all these parameters and their effect on 4G system in this research. We have also compare 4G Network and technologies with other technologies and different operators. We have compare Bit error rate (ratio of number of bits lost to the total number of bits transmitted) with SNR (signal to noise ratio). This is compared considering different medium (noisy and fading). We have simulated by considering minimum 10000 and maximum 100000 bits of data also different modulation schemes have been used. Different operators are using different modulation schemes and hardware we have also done comparison among the operators. As it can be seen in the result between BER and SNR, we are increasing SNR from 5 decibel to 25 decibel as the SNR is increasing that means noise is reducing and thereby BER is reducing as shown in the result. Since noise is reduced there will be minimum loss of information (bits) and so BER is reducing. Also if we compare all the operators performance of BER versus SNR than it can be said that operator 1 has best performance among all operators. In this result also the operator 5 has the poorest BER performance.

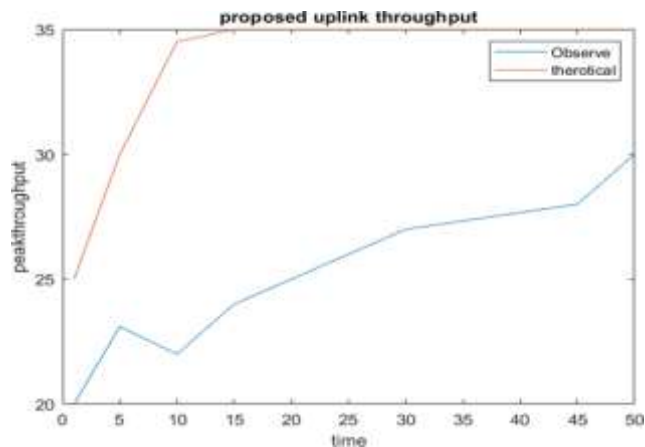

Figure 7: BER vs SNR

In the second result which is plot between throughput Vs mobile speed. Throughput is the packet transmission speed and node mobility is the speed at which mobile nodes are moving. We have also compared it for all different operators. This whole system we have simulated in MATLAB environment where we have assign different speed to various nodes and the nodes are moving randomly. As they are moving there will be fading and signal will not be received line of sight so there will be loss of packets. Node mobility we are varying from 1 to 12000 feet/min and at each value we are calculating the number of packets it supports. From the comparison it is clear that operator1 has the maximum throughput as compare to others and operator 4 has the minimum.

In the last result we are analyzing source to destination (end to end) delay versus mobile speed. This parameter is also important in wireless communication because several factors affect end to end delay. Again we have simulated this in MATLAB environment we have varied node speed and we have measured node to node delay for various nodes. We are varying node speed from 1 to 12000 feet/min and measuring delay between 4.5 second to 9.5 second. From the results it can be concluded that the performance is mixed type performance but still operator1 gives good result as compare to others.

**RESULT 1-** (From Figure 7 BER vs. SNR), as the SNR is increasing that means noise in the atmosphere is reducing and therefore less number of bits(data) will be lost so BER is reducing. In result 1 the operator1 has the best performance.

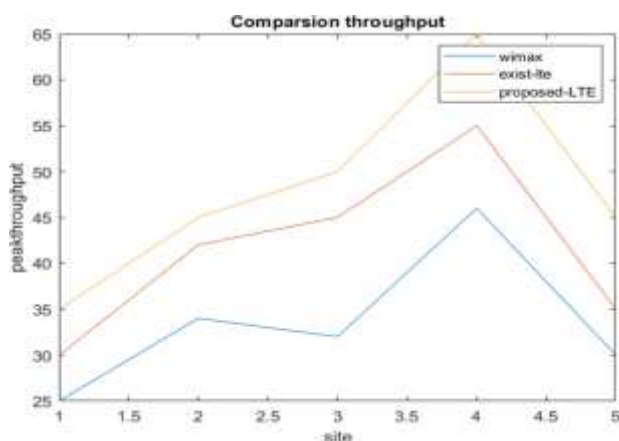

Figure 8: Peak throughput – Wimax, Exist-LTE and Proposed LTE

**RESULT 2** – (From Figure 8) As the node mobility is increasing that means mobile nodes are moving with fast rate so more chances of data (packets) lost, throughput scale in figure shows that at different node mobility different operator can support different packet transfer rate. Operator1 has the best performance.

## V. CONCLUSIONS

In this research, comparative analysis in real world scenario with LTE signal using the different number of operator1 (QPSK), operator 2(BPSK), operator3 (NCG), operator4 (CG), operator 5 4G-LTE system. The comparison with different operator in presence of noises in occurrence of interference illustrations that in occurrence of only noise and in absence of interference, drastic variation. This research has discussed numerous significant contributions of the earlier research attempts. The major assumption of the research was to appreciate the efficiency in the techniques for improving the LTE network from the viewpoint of developing packet system. It was correspondingly created that there were important studies done towards reviewing the existing analysis too.

## CONFLICTS OF INTEREST

The authors declare that they have no conflicts of interest.

## REFERENCES

- [1] Ahmed, F & Tirkkonen, O 2016, 'Simulated annealing variants for self-organized resource allocation in small cell networks', *Applied Soft Computing*, vol. 38, pp. 762-770.
- [2] Assaad, M, 2008, 'Optimal fractional frequency reuse (FFR) in multicellular OFDMA system', *Vehicular Technology Conference*, pp. 1-5.
- [3] Elayoubi, SE, Haddada, OB & Fourestie, B 2008, 'Performance evaluation of frequency planning schemes in OFDMA-based networks', *IEEE Transactions on Wireless Communications*, vol. 7, no. 5, pp. 1623– 1633.
- [4] Jahagir Khan et al., 2015, "5G Mobile Communications A mandatory wireless infrastructure for Big data", *Third International Conference on Advances in Computing, Electronics and Electrical Technology - CEET 2015*
- [5] Kubbar et al., 2012, "A fairness-based preemption algorithm for LTE-Advanced", *Qatar Foundation Annual Research Forum Proceedings*, 2012.
- [6] Tang, M, Xin, Y, Li, J & Zhai, J 2013, 'Nonconvex resource control and lifetime optimization in wireless video sensor networks based on chaotic particle swarm optimization', *Applied Soft Computing*, vol. 13, no. 7, pp. 3273-3284.
- [7] Van Nguyen, M, Sungwon, LE & Hong, CS 2013, 'Joint rate adaption, power control, and spectrum allocation in OFDMA-based multi-hop CRNs', *IEICE Transactions on Communications*, vol. 96, no. 1, pp. 242-253
- [8] Wang, YC & Hsieh SY 2016, 'Service-differentiated downlink flow scheduling to support QoS in long term evolution', *Computer Networks*, pp. 344-359.
- [9] Xiang, Y, Luo, J & Hartmann, C 2007, 'Inter-cell interference mitigation through flexible resource reuse in OFDMA based communication networks', *European wireless*, pp. 1-7
- [10] Zhang, X, He, C, Jiang, L & Xu, J 2008, 'Inter-cell interference coordination based on softer frequency reuse in OFDMA cellular systems', *Neural Networks and Signal Processing*, pp. 270-275
- [11] Zhao Q, Liew, SC, Zhang, S & Yu, Y 2016, 'Distance-based location management utilizing initial position for mobile communication networks', *IEEE Transactions on Mobile Computing*, vol. 15, no. 1, pp. 107-120.